

JOHN E. POTENTE & SONS, INC.

ITEM NO: CB3x3

114 WOODBURY ROAD
PHONE (516) 935-8585

HICKSVILLE, N.Y. 11801
FAX (516) 935-8546

DWG. NO:

000907

PAT NOS:

MAT. AS NOTED:

WT.

DR

DR. BY: P. FOREMAN

DATE: 09/07/00

CK

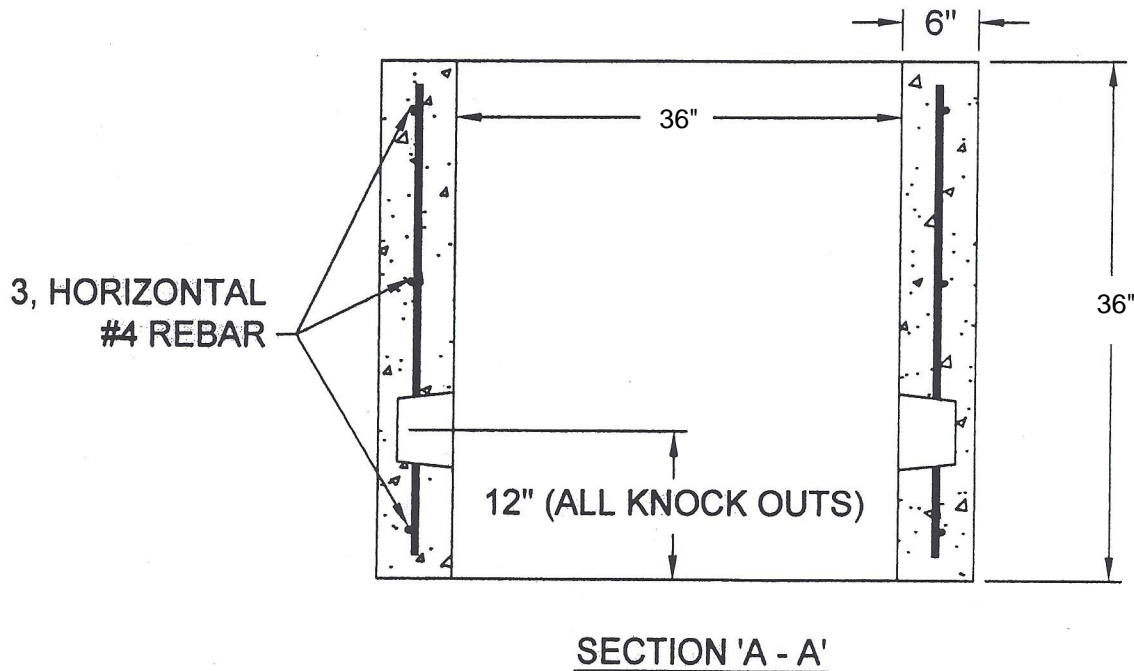
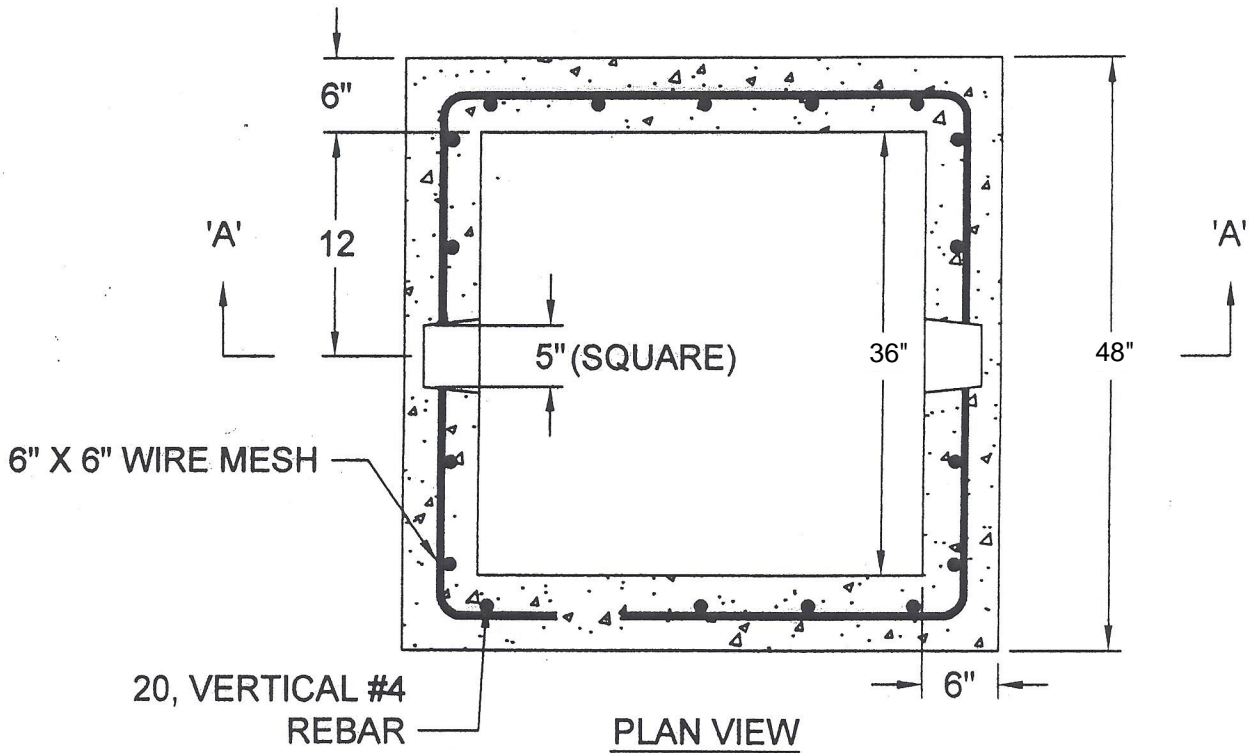

- NOTES: 1) CONCRETE TO ATTAIN 4,000 PSI @ 28 DAYS.
2) ASTM A185 WIRE MESH.
3) H-20 LOADING.